

## Secondary- and Large-size Display Units



- High contrast, easily-readable display
- Rugged industrial design
- Protection type as far as IP65
- Temperature range to  $-30\text{ °C}$  ...  $+60\text{ °C}$
- Legal-for-trade

### Application

The digital display units are designed for large-size display of weight values. They are used on all industrial weighing systems which require the weight to be read from long distances, e.g. crane scales, scales for racking systems, road weigh-bridges.

### Equipment

The display uses either LED- or LCD-technology, depending on type. The swivel housings are fixed with mounting brackets.

### Functions

Display of the weight value with additional symbols for sign, unit and operating status.

## Display dimensions

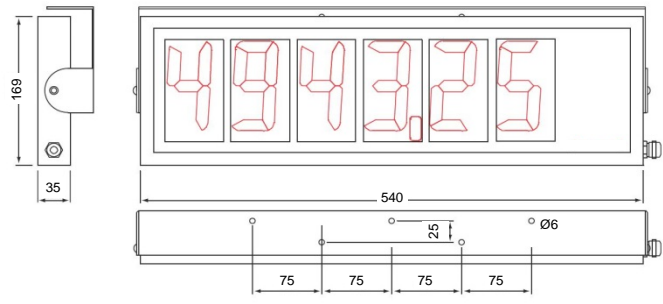

VLZ 2010

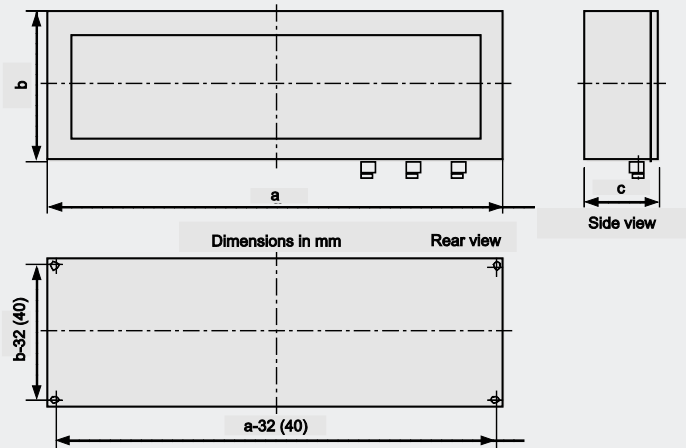

DLS 160-250

Dimensions in brackets apply to variants with 160 and 250 mm digit height.

Dimensions [mm]	a	b	c
DLS 160	1100	300	145
DLS 250	1730	400	165

VLD 2010

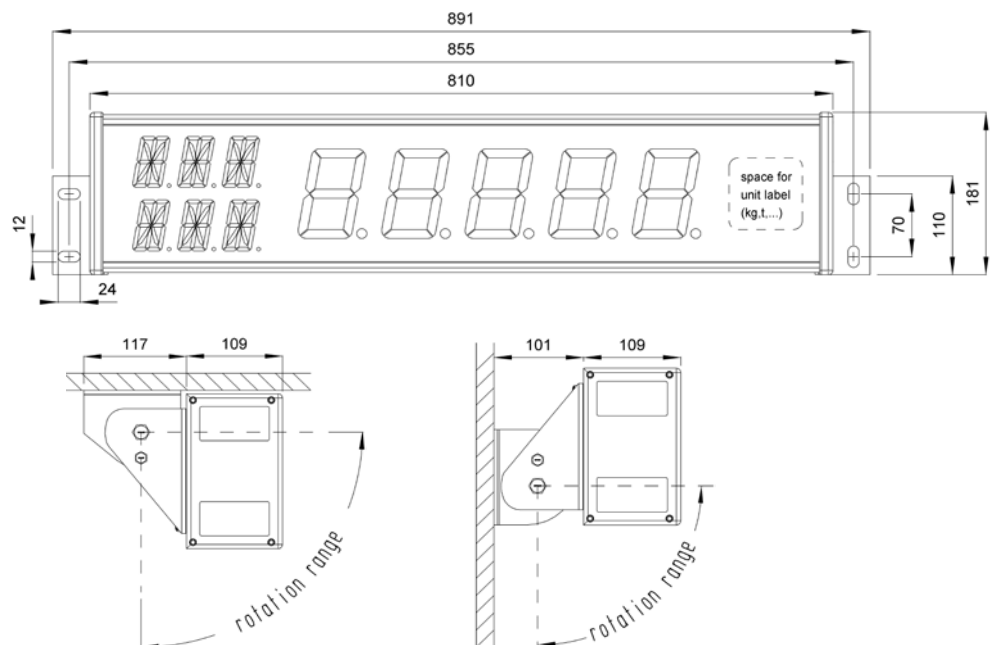



VLZ 20045

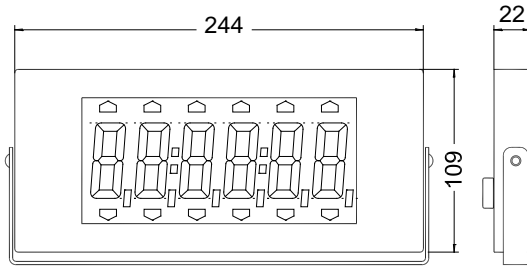

VAG 20200-D

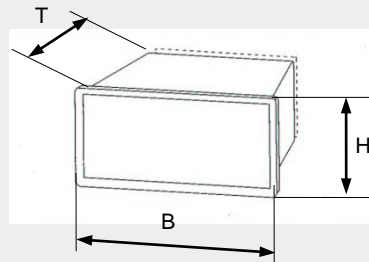
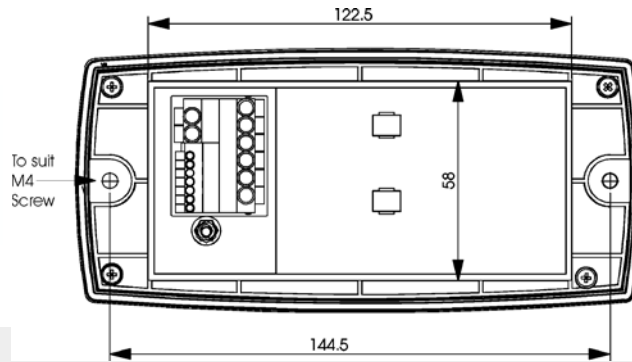

Dimensions [mm]	B	H	T	Cut-out
VLZ 20151	96	48	115	92 x 45
VLZ 20250	144	72	72	138 x 68

VLZ 20151  
VLZ 20250



DLZ 030 E

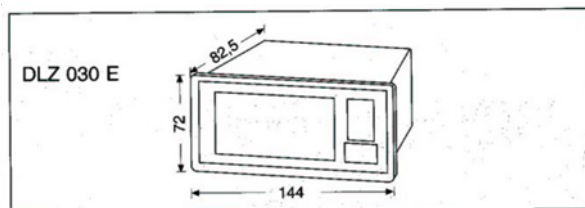

DLZ 030 EF  
DLZ 050 EF

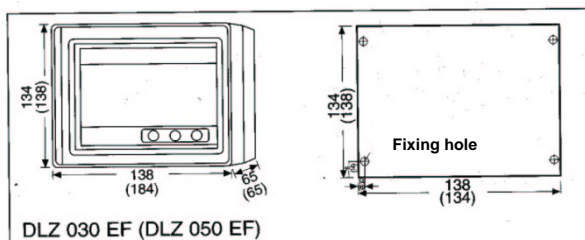

## Technical Data

	VLD 20100	DLS 160	DLS 250	VLZ 20100	VLZ 20045
Display principle	LED	LED		LCD	
Display colour	Red	Red		Black, white backlight	Black, amber backlight
Number of digits	5	5		5	6
Digit height [mm]	100	160	250	100	45
Unit	g, kg, t (Adhesive symbols)	g, kg, t		g, kg, t, lb	----
Status display	Zero, tare, net	Zero, tare, net, no-motion		Zero, tare, net	----
Reading distance	40 m	60 m	100 m	40 m	15 m
Protection type	IP54	IP54		IP65	
Temperature range	-20 °C ... +45 °C	0 °C ... +55 °C		-30 °C ... +60 °C	-10 °C - +60 °C
Legal-for-trade	Yes	Yes		Yes	No
Mounting variant	Floor, wall and ceiling mounting	Floor, wall and ceiling mounting		Wall or ceiling mounting	
Weight approx.	7.4 kg	21 kg	40 kg	4.5 kg	0.8 kg
Swivel-mounted	Yes	No, bracket for swivel- mounting available as option		Yes	
Data interface	RS423, RS232	RS232		RS232, RS485, TTY 20 mA	
Power supply	100 ... 240 VAC (47 ... 63 Hz); max. 40 W	230 VAC +15/-10 % (47 ... 63 Hz)		24 VDC, 100 mA	24 VDC, 60 mA
Max. cable length approx.	100 m	100 m		600 m	
Order No.	V090252.B01	E909054.02/04		V066611.B01	V067304.B01

	VLZ 20151	VLZ 20250	DLS 030E / DLZ 030EF / DLZ 050EF	VAG 20200-D
Display principle	LED, 7-Segment		LCD	LCD
Colour	Red		Black	Black
Number of digits	6	5	4	6
Digit height [mm]	14	25	30 / 30 / 50	20
Unit	g, kg, t		Selectable	kg, t, lb
Protection type	IP40, optional IP65	IP40	IP40 / IP65 / IP65	IP54 front
Temperature range	0 °C ... 60 °C		-10 °C ... 50 °C / 65 °C / T5	-10 °C ... +50 °C
Legal-for-trade	No	No	No	Yes
Explosion-proof design	No		Ex ib IIC T6 for ATEX Zone 1	No
Mounting variant	Panel-mounting		Panel-mounting/filed housing/filed housing	Panel-mounting
Data interface	RS232, RS422 / RS485 / TTY 20 mA		Analog 4 ... 20 mA	RS232
Power supply	16 ... 30 VDC, 230 VAC optional		---	12 ... 24 VDC
Max. cable length approx.	100 m		750 m	15 m
Order No.	V036225. B01/B02	E054593.01	E909034.01 / E909034.02 / E909033.01	V070449.B01